

# SITE**L**Ab

Multipath Ultrasonic Flowmeter  
SL3488D

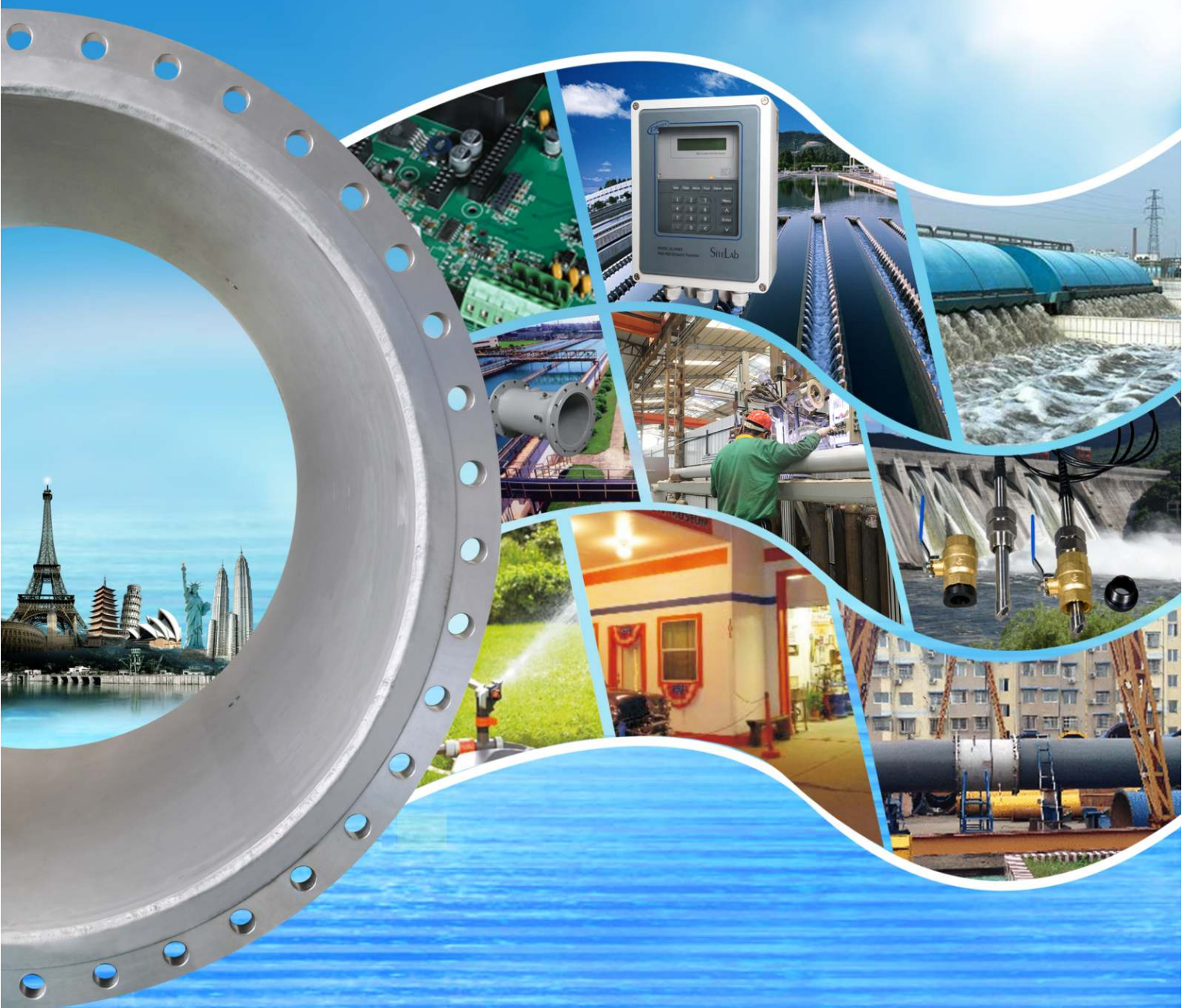

## About SL3488D

This ultrasonic flowmeter adopts Gentos unique PICOFLY time measurement technology, which could make the resolution reach to 10 picoseconds(0.01 nanosecond). It realizes the high response and high accuracy ultrasonic measurement technology and application. The sampling rate could reach to 1000 times/second. It could be applied to sorts of industrial and commercial applications.

With distinctive features such as high precision, high reliability, high capability and low cost, the flowmeter features other advantages:

Low consumption power, high reliability, anti-jamming and outstanding applicability.

Clear, user-friendly menu selections make flowmeter simple and convenient to use.

Daily, monthly and yearly totalized flow

Parallel operation of positive, negative and net flow totalizes with scale factor (span) and 7 digit display, while the output of totalizer pulse and frequency output are transmitted via relay and open collector.



## Production Scene(Spool Piece)



We have a 3000m<sup>2</sup> pipeline processing plant, the whole processing includes the stainless steel plate cutting, reelpipe, welding and flange mating, then to polishing and pickling etc...

Non-destructive testing is strictly carried out during the whole process of welding. With material testing report, it could reach to the design requirements.

## Specification

Performance specifications	
Flow range	0.01~7m/s(0.03~23ft/s)
Accuracy	Spool piece type: $\pm 0.2\%$ of measured value
	Insertion type: $\pm 0.5\%$ of measured value
Repeatability	Spool piece type: 0.07%
	Insertion type: 0.15%
Pipe size	Spool piece type: 150mm~3000mm(6"~120")
	Insertion type: 150mm~3000mm(6"~120")
Function specifications	
Outputs	Analog output: 4~20mA (max load 750 $\Omega$ ) Analog output Pulse output: 0~10KHz, OCT Relay output: 125VAC@1A or 30VDC@2A Communication: RS232/RS485
Power supply	90~245VAC, 48~63Hz or 12~36VDC
Keypad	22 keys with tactile action
Display	40 character, 2line (20 $\times$ 2) lattice alphanumeric, backlit LCD
Temperature	Transmitter: -10 $^{\circ}$ C (14 $^{\circ}$ F~140 $^{\circ}$ F)
	Transducer: -40 $^{\circ}$ C~80 $^{\circ}$ C (-40 $^{\circ}$ F~176 $^{\circ}$ F)
Humidity	Up to 99% RH, non-condensing
Physical specifications	
Transmitter	Protection grade: IP65, Hazardous Rating: Exia IIB T4
Transducer	Protection grade: IP68, sealing design Standard/maximum cable length: 30ft(9m)/344ft(105m)

## Wiring Diagram

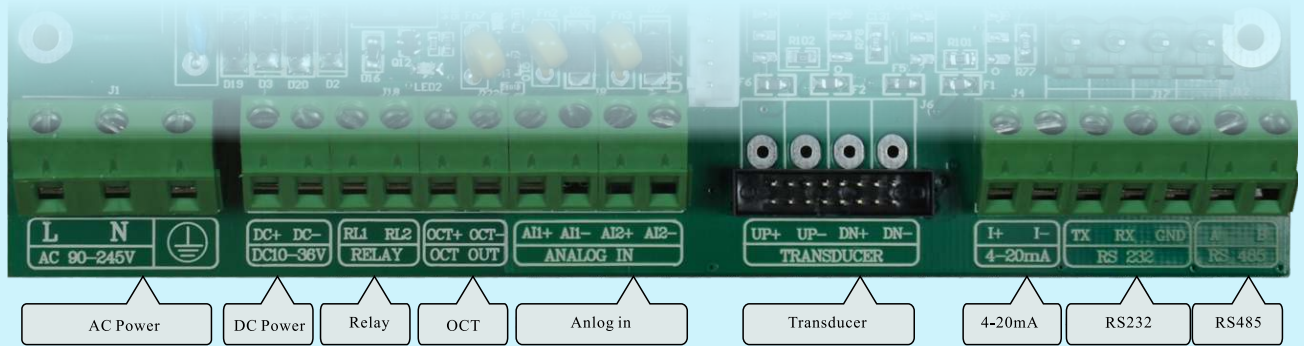

## Applications



DN800 Water Supply



Insertion Transducer Installation

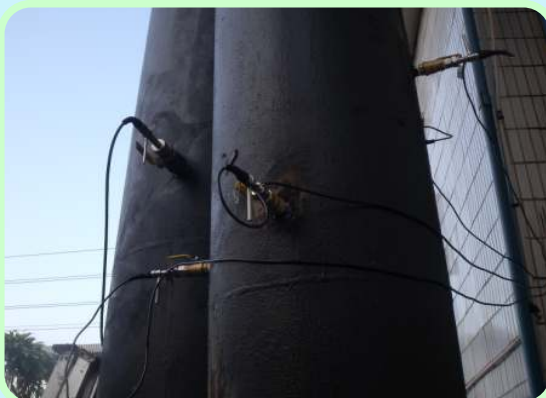

DN1000 Circulation Cooling Water



Sewage Treatment



Power Plant Circulation Water

## Transmitter Dimensions

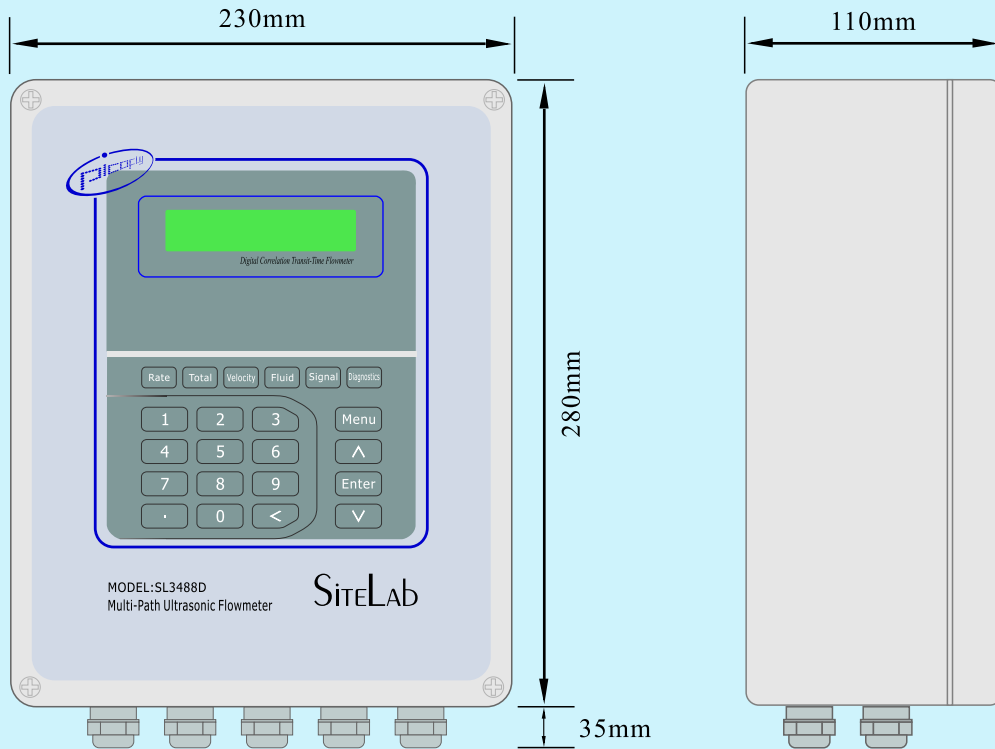

## Transducer Dimensions

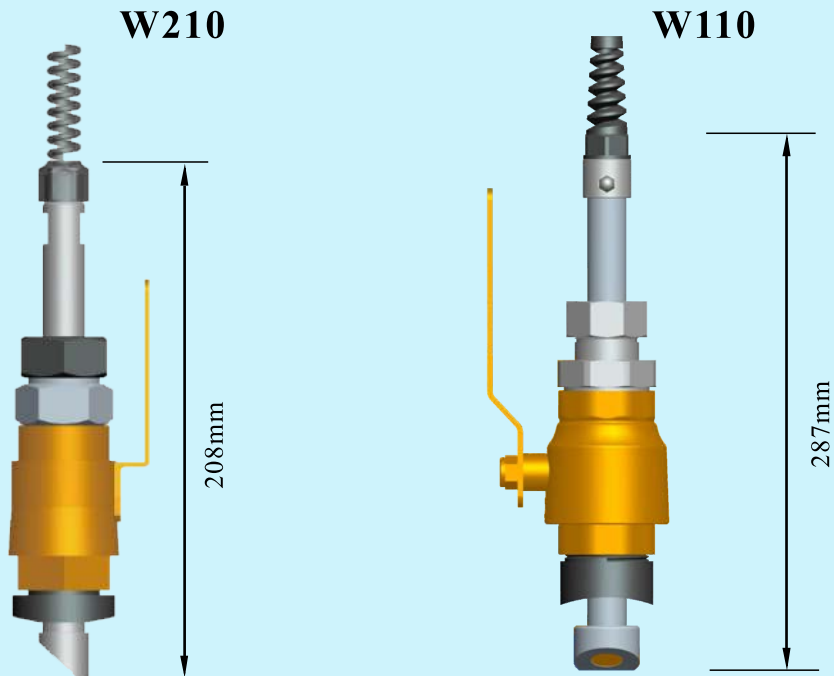

Remarks:

4

- SL3488D-W210 Pipe size: 150-1200mm
- SL3488D-W110 Pipe size: 150-3000mm

## Flange Dimensions

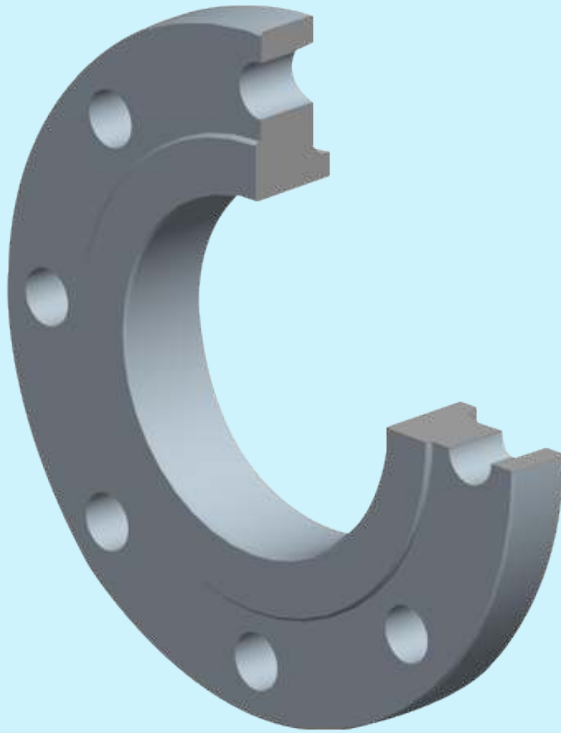

Pipe Material: Carbon steel

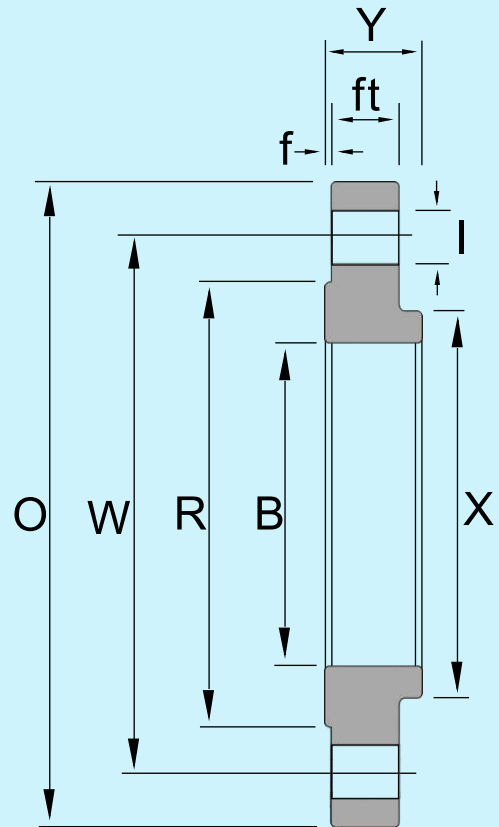

NPS	DN	Overall Diameter O	Diameter of Circle Holes W	Bolt Hole Diameter I	Number of Holes n	Face Diameter R	Raised Face f	Flange Thickness ft	Threaded/s lip-on/socket Welding Y	Hub Diameter X	Inside Diameter B
4	DN100	230	190.5	19.1	8	157.2	2	23.9	32	135	116.1
5	DN125	255	215.9	22.3	8	185.7	2	23.9	35	164	143.8
6	DN150	280	241.3	22.3	8	215.9	2	25.4	38	192	170.7
8	DN200	345	298.5	22.3	8	269.9	2	28.6	43	246	221.5
10	DN250	405	362.0	25.4	12	323.8	2	30.2	48	305	276.2
12	DN300	485	431.8	25.4	12	381.0	2	31.8	54	365	327.0
14	DN350	535	476.3	28.6	12	412.8	2	35.0	56	400	359.2
16	DN400	595	539.8	28.6	16	469.9	2	36.6	62	457	410.5
18	DN450	635	577.9	31.8	16	533.4	2	39.7	67	505	461.8
20	DN500	700	635.0	31.8	20	584.2	2	42.9	71	559	513.1
24	DN600	815	749.3	35.0	20	692.2	2	47.7	81	663	616.0

The above Chart quotes the ASME B16.5-2009 flange.  
 P64: Chart 4 - Flange processing surface dimensions  
 P71: Chart 7 - 150 Grade flange drill template  
 P73: Chart 8 - 150 Grade Flange dimensions

## Spool piece Dimensions

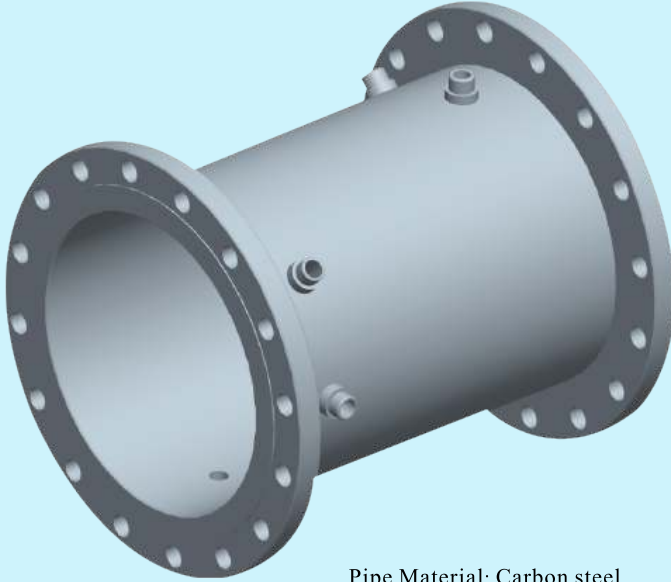

Pipe Material: Carbon steel

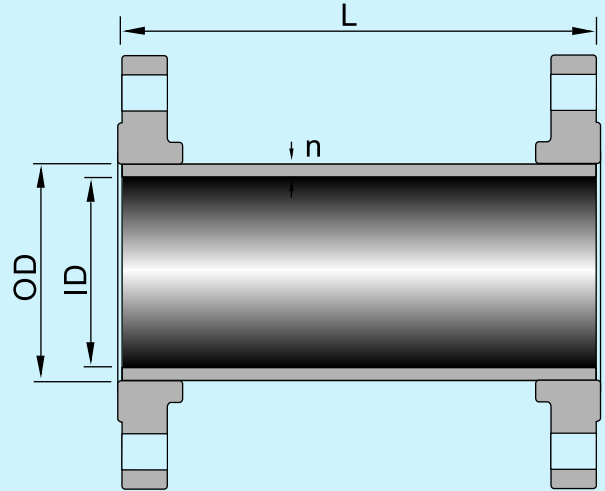

NPS	DN	Length L	Outer Diameter OD	Inner Diameter ID	Thickness n	Flang Weight KG	Spool Piece Weight KG
4	DN100	400	114.30	102.26	6.02	5.7	18.8
5	DN125	420	141.30	128.20	6.55	6.5	22.7
6	DN150	450	168.30	154.08	7.11	7.7	29.0
8	DN200	510	219.10	202.74	8.18	12.2	46.5
10	DN250	580	273.00	254.46	9.27	16.2	66.5
12	DN300	640	323.80	304.74	9.53	25.0	97.2
14	DN350	680	355.60	336.54	9.53	33.7	122.5
16	DN400	740	406.40	387.34	9.53	41.6	151.8
18	DN450	780	457.00	437.94	9.53	46.2	173.9
20	DN500	860	508.00	488.94	9.53	59.5	219.9
24	DN600	980	610.00	590.94	9.53	83.2	303.4

The above Chart quotes the ASME B36.10M-2004 flange.  
P5: Chart 1 – The weld and rolled seamless steel tube dimension and weight

Remarks:  
We also provide the DIN, JIS EN and other different standard pipe and flange.  
Here customer need to provide operation standard and drawing, then the prices are re-definition.  
Customer also need to provide operation standard and drawing for large pipe and flange.

## Transducer Installation Methods

V method

V method measuring pipe size : 150mm-1200mm

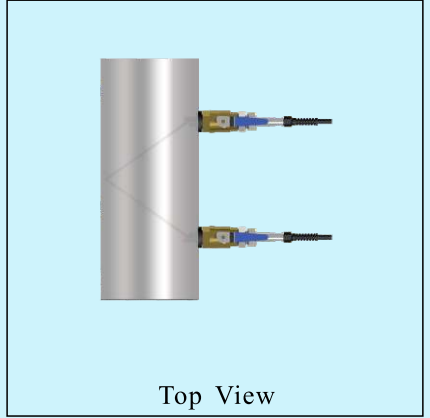
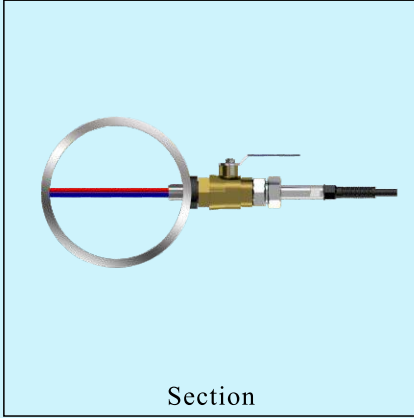
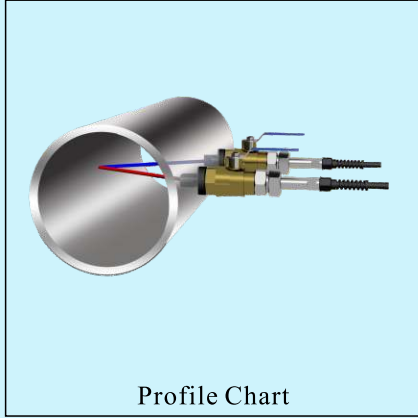

Z method

Z method measuring pipe size: 100mm-3000mm

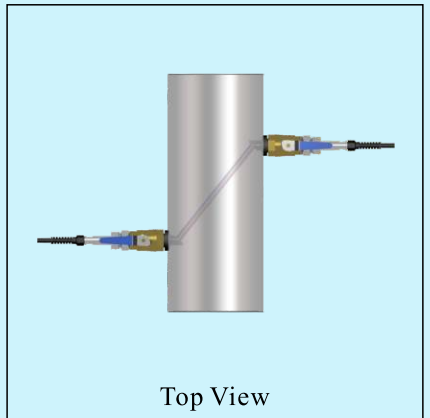
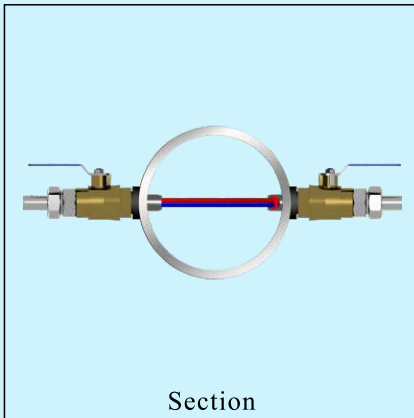
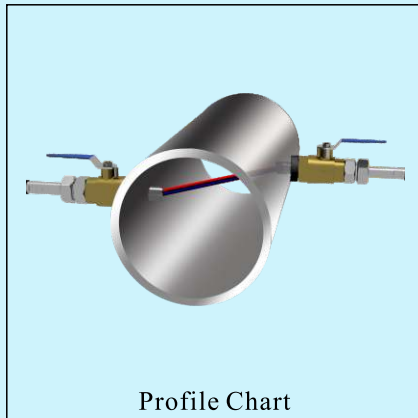

## Test By The Third Party

According to the customer's requirement, products can be tested by the third party.





## Installation Site Selection

When selecting a measurement site, it is important to select an area where the fluid flow profile is fully developed to guarantee a highly accurate measurement. Use the following guidelines to select a proper installation site:

1. Choose a section of pipe that is always full of liquid, such as a vertical pipe with flow in the upward direction or a full horizontal pipe.

2. Ensure enough straight pipe length at least equal to the figure shown below for the upstream and downstream transducers installation.

3. Ensure that the pipe surface temperature at the measuring point is within the transducer temperature limits.

4. Consider the inside condition of the pipe carefully. If possible, select a section of pipe where the inside is free of excessive corrosion or scaling.

### Straight length of upstream piping

### Straight length of downstream piping

#### 90° Bend

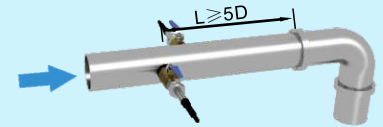
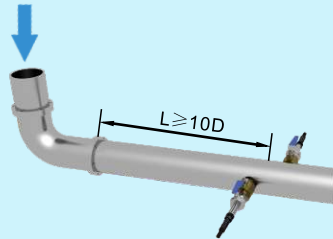

#### Tee

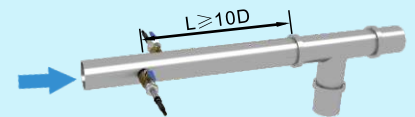
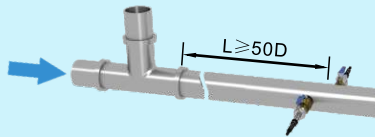

#### Diffuser

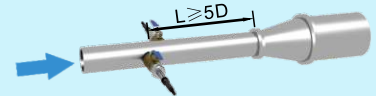
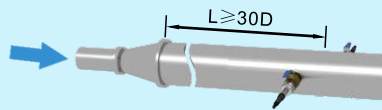

#### Reduce

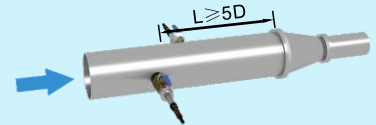
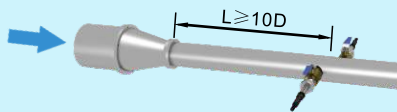

#### Valve

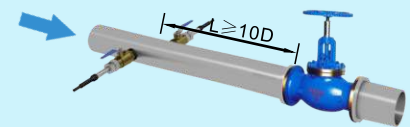
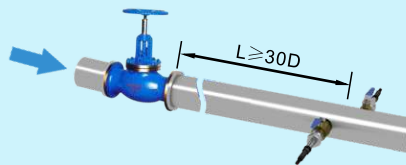

#### Vertical

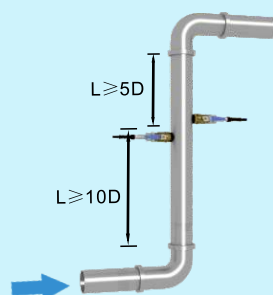

#### Pump

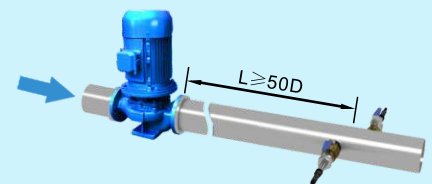

## Ordering Information

Model	Description
SL3488D	Multi-path Ultrasonic Flowmeter Installation Method: Wall mount Flow Range: 0.03~±23ft/s(0.01~±7m/s) Accuracy: ±0.5%(±1.6ft/s~±16ft/s) Repeatability: 0.15% Pipe Size Range: 6"~120"(150mm~3000mm) Keyboard: 16(4×4) touch keys Function Key: 6 touch keys Display: 20*2, alphanumeric, backlit LCD Power Supply: 90-250VAC, 48-63Hz, or 12~36VDC
Code	Output
1	4-20mA, OCT pulse output, relay output, RS-232 / RS-458 terminal Modbus Protocol
Code	Transmitter enclosure area classification
1	IP65, die-cast aluminum machined enclosure
2	Explosion-proof enclosure, Exd II BT4
Code	Type of Temperature sensor
2	2 channel (pipe size over DN150)
3	3 channel (pipe size over DN300)
4	4 channel (pipe size over DN400)
6	6 channel (pipe size over DN600)
Code	Type of transducers
W	Wetted transducer, Operating temperature: -40°F ~ +176°F (-40°C ~ +80°C)
Code	Transducer Cable Length
030	Standard 30ft(9m)
xxx	Maximum lengthen to 105m(344ft), per 5m is lengthen unit.
Standard Model: SL3488D-1-1-2-W-030 Description: Multi-path Ultrasonic flowmeter, 4-20mA output, two channel path wetted transducer with 9m cable.	

## Product Line

### SL1168 Dedicated Ultrasonic Flowmeter



Accuracy:  
±1.0%  
Flow range:  
0.03 ~±16ft/s  
Pipe Size Range:  
1"~48"

### SL1168P Portable Ultrasonic Flowmeter



Accuracy:  
±1%  
Flow range:  
0.03 ~±40ft/s  
Pipe Size Range:  
1"~48"

### SL1188 Dedicated Ultrasonic Flowmeter



Accuracy:  
±0.5%  
Flow range:  
0.03 ~±40ft/s  
Pipe Size Range:  
1"~200"

### SL1288i Portable Ultrasonic Flowmeter



Accuracy:  
±0.5%  
Flow range:  
0.03 ~±40ft/s  
Pipe Size Range:  
1"~200"

### SL3488D Multipath Ultrasonic Flowmeter



Accuracy:  
±0.5%  
Flow range:  
0.03~±23ft/s  
Pipe Size Range:4"~120"

### Application

Perfect performance in single liquid medium.  
Eg: Water, Pure water, Beer, Oil, etc.

Remark: The above mode choose doesn't including the spool piece, it is for customization.

#### Gentos Measurement & Control Co., Ltd.

12/F, Block A5, Nanshan Ipark, No.1001 College Rd.  
Nanshan District, Shenzhen CHINA  
Tel: 86-755-26745999  
Fax: 86-755-26745333  
E-mail: intl@gentos.com.cn

Reps: